

MRD

$Q \leq 800 \text{ KG}$

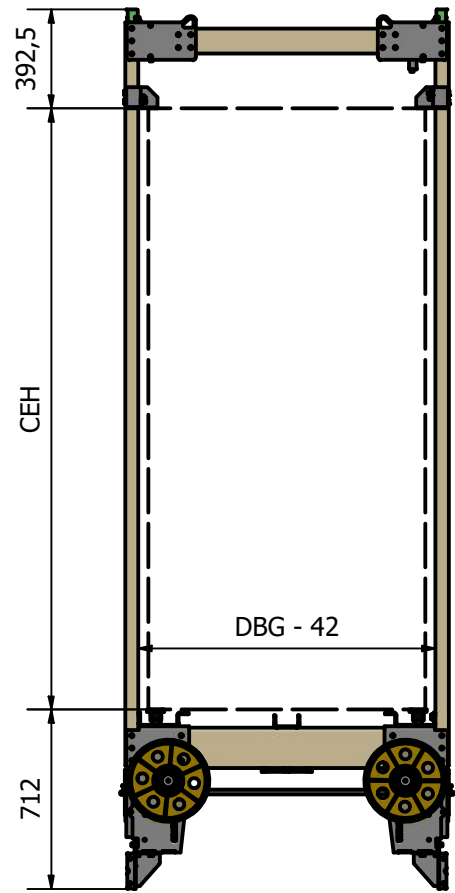

$800 \text{ KG} < Q \leq 1600 \text{ KG}$

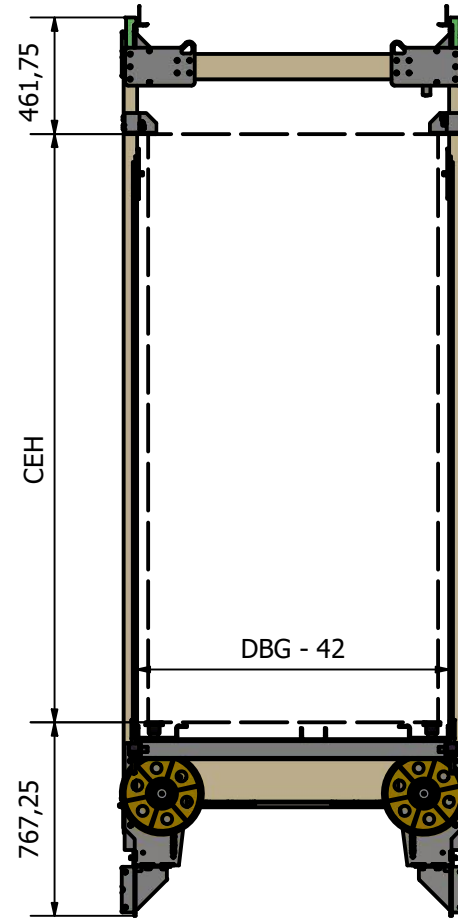

$1600 \text{ KG} < Q \leq 2500 \text{ KG}$

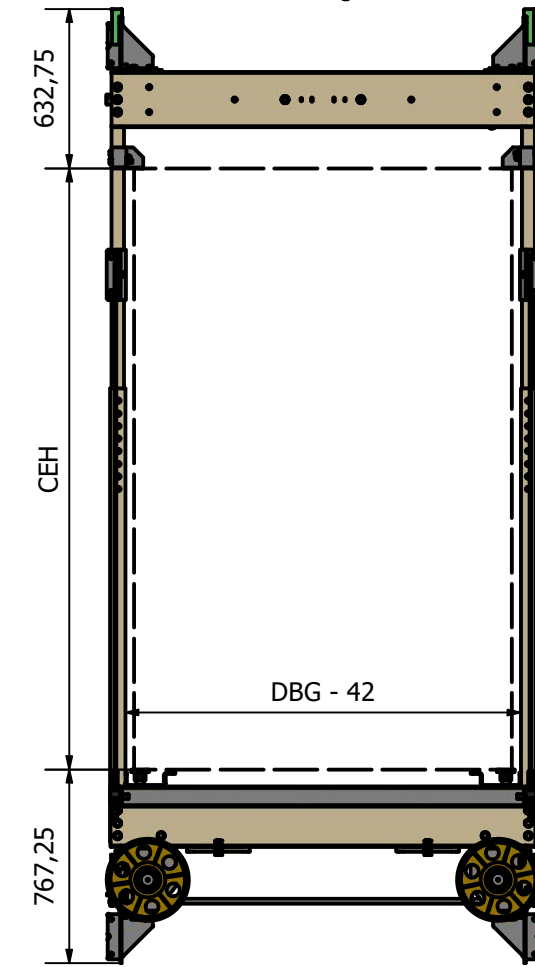

MAX DBG : 1630 mm

DBG : CIW + 130

MAX CID : 1800 mm

CED - 140

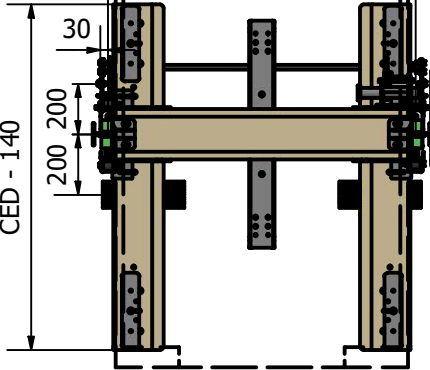

MAX DBG : 2230 mm

DBG : CIW + 130

MAX CID : 2600 mm

CED - 140

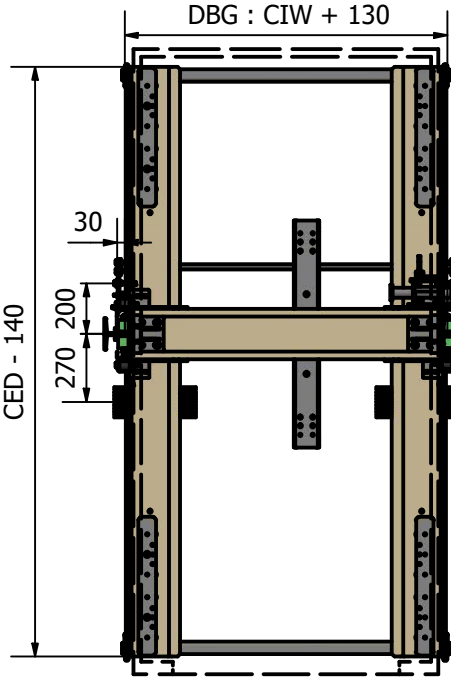

MAX DBG : 2830 mm

DBG : CIW + 130

MAX CID : 3200 mm

CED - 140

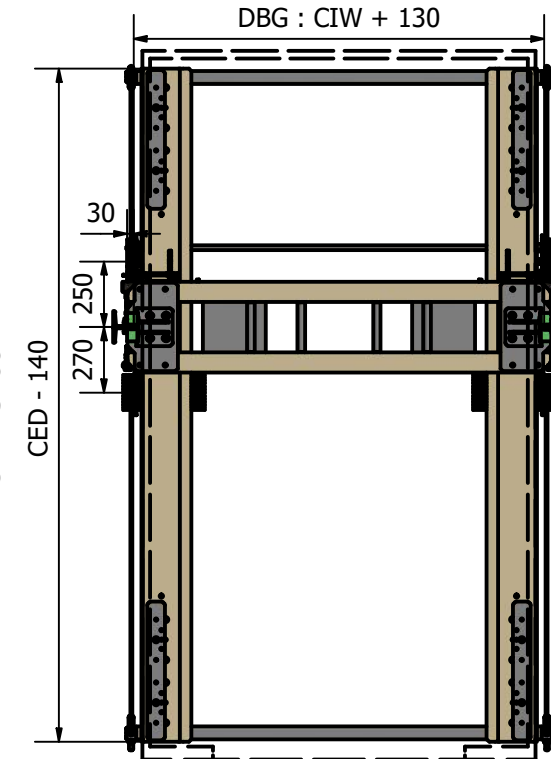

Designed by S.KOÇ	Checked by N. ERBİRER	Material	Weight N/A	Date 4.12.2019	Area N/A
			MRD	Edition	Sheet 1 / 1

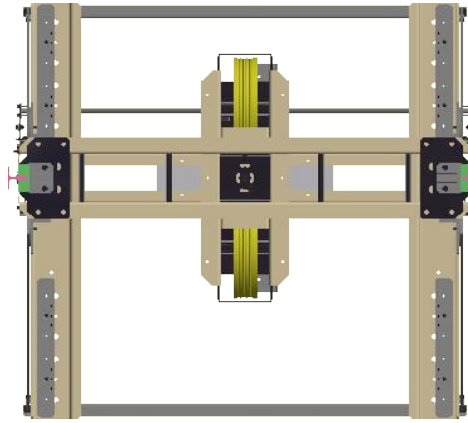
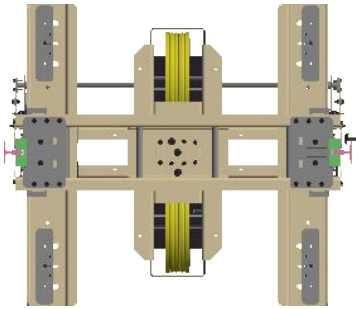
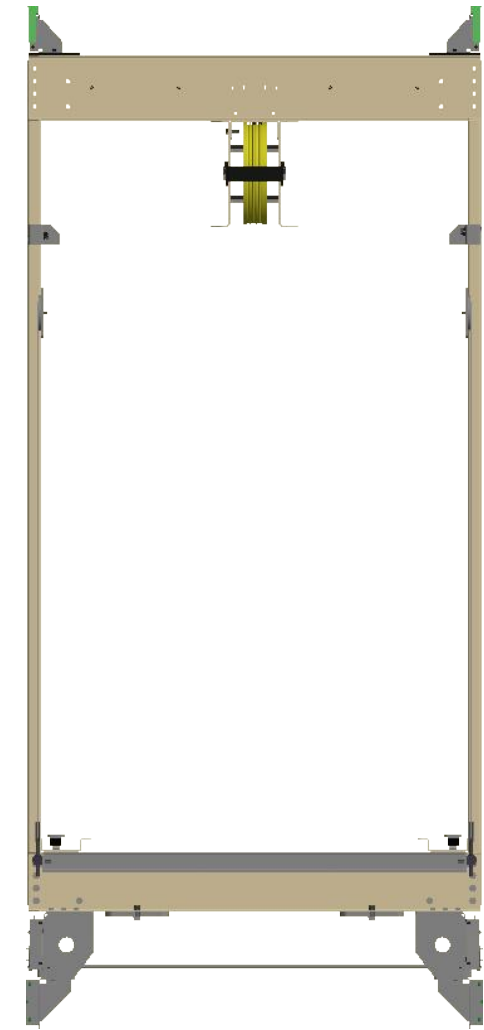
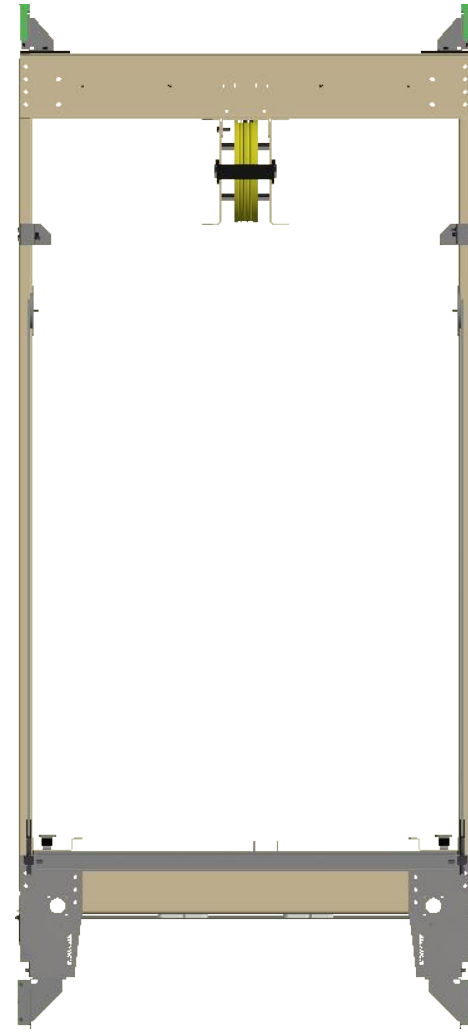
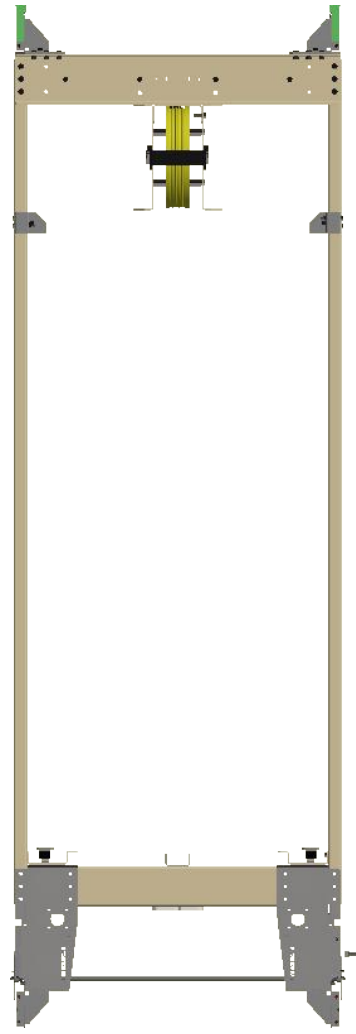

TRS

$Q \leq 800 \text{ KG}$

$800 \text{ KG} < Q \leq 1600 \text{ KG}$

$1600 \text{ KG} < Q \leq 2500 \text{ KG}$

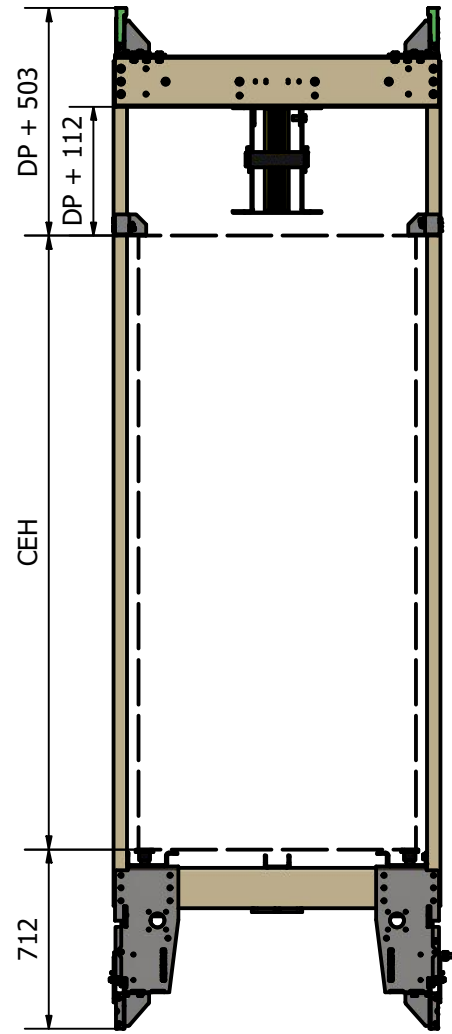

MAX DBG : 1630 mm

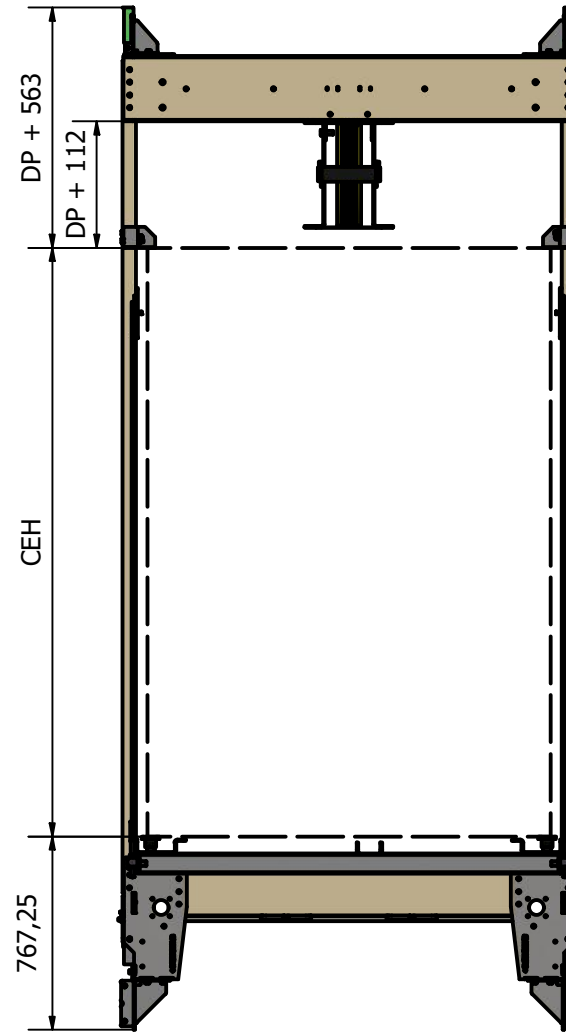
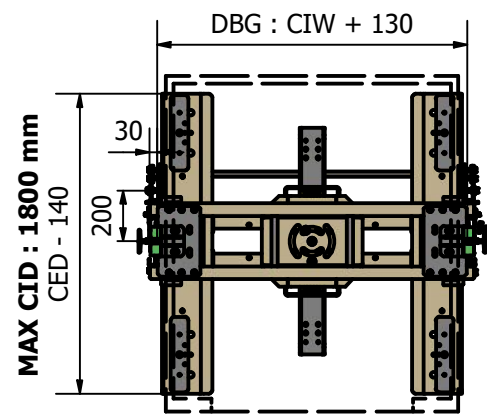

MAX DBG : 2230 mm

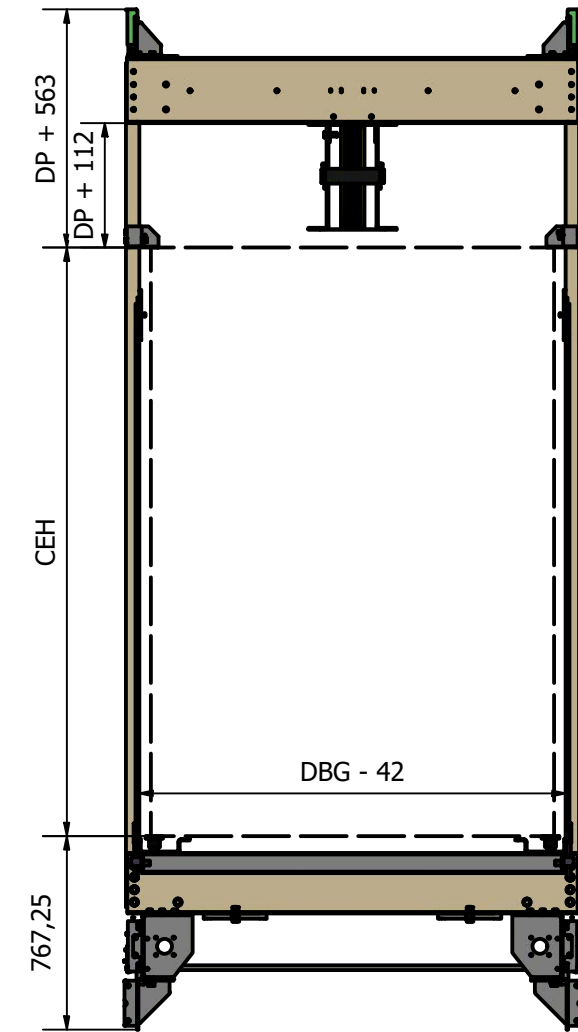
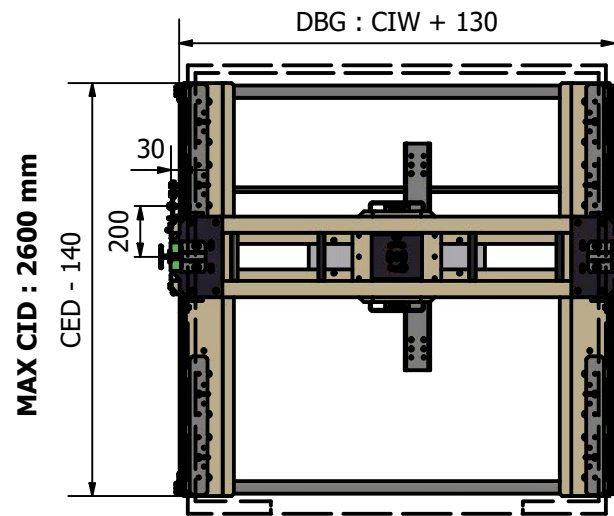

MAX DBG : 2830 mm

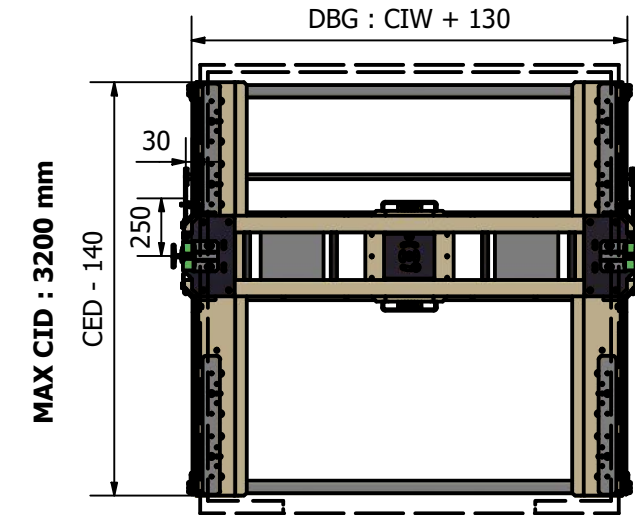

Designed by S.KOÇ	Checked by N. ERBİRER	Material	Weight N/A	Date 4.12.2019	Area N/A
TRS			Edition	Sheet 1 / 1	